

CWTTM

WORKTOOLS USA

Finishing What You Started

APEX & APEX Plus

Affordable High Speed Digital Cutting System

APEX



Camera Registration
Auto Knife Calibration
Oscillating Knife Tools
Kiss Cut Tools
Drag Knife Tools
V-Cut
Ceasing Tools
Drive Rotary Tool
Router

Apex digital cutters are perfect for a variety of finishing requirements for displays, die cutter, graphics, POP and sign markets. Increase your productivity and profitability by having an in house multi-function digital cutting solution that can cut, crease, decal cut, oscillate cut materials up to 1.5" thick.



APEX Plus



Shown with Optional
5' x 10' Conveyor

PRINTING United Alliance Product of the Year 2020 in Lasers – Routers - Cutters 4'x8' or smaller



Optional 1kW Router

Milling up to 60,000 RPM for cutting Acrylic, MDF, ABS plate & other hard materials.

KEY POINTS

- 27 years of engineering from Manufacture focused on the digital cutting market
- Affordable full package solutions
- Aircraft aluminum table for precision and accuracy
- Multizone vacuum system for focused material hold down
- Offering both static and conveyor table solutions
- Auto sheet feeding system for increased production available
- True 3 tool positions available with all tool combinations
- 3 Tool Module positions for variation of tool selection
- Optical Auto Tool calibration
- Automatic tool changing available for Apex Plus
- Products for Graphics, Packaging, Textile, Die-cutting and Gasket



OPTIONAL

Optical Auto Tool Calibration

Control the cutting depth accuracy with displacement sensor through automatic knife initialization

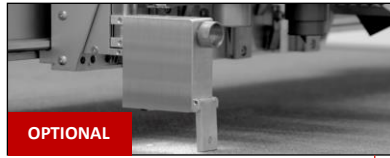

OPTIONAL

Precise Automatic Positioning System

With the high precision CCD camera the Apex accounts for multiple types of printer distortion that matches up for high accuracy cuts

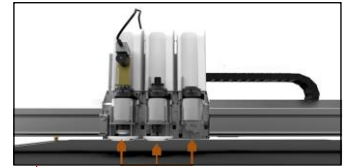

Efficient Cutting Heads

The max cutting speed is 1.m/s (4 to 6 times faster than manual cutting) which will considerably increase the production efficiency



OPTIONAL

Continuous Cutting System

Automated conveyor system makes feeding, cutting and collection work together. Continuous cutting function can cut long pieces saving labor cost and increasing productivity.

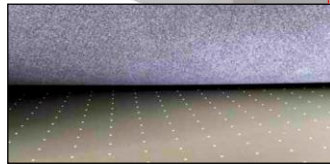

Precision Aluminum Table

With multiple vacuum zone system for accurate material hold down.

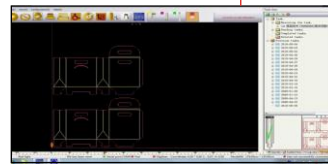

Motion Control System

Cutter Server makes the cutting process smooth, effective and perfect



Safety Device

Safety device system shutdown ensures the security of the operator



Precision Control System

X & Y Drive by Belt
15 Vacuum Zones

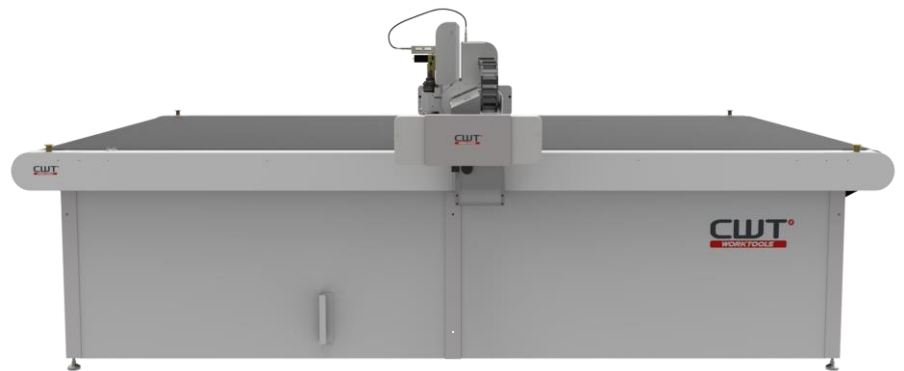
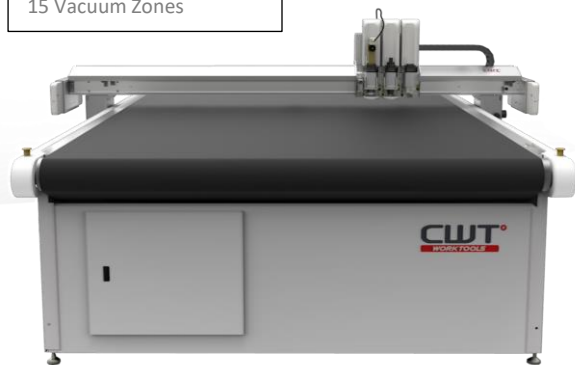

Max Cutting Speed	1500mm/s 59 in/s
Cutting Accuracy	0.1mm
Max. Cutting Thickness	50 mm 1.96 in
Data Format	DXF, HPGL, PDF
Interface	Serial Port
Media	Vacuum System
Pump Power	220v 3 Phase 60 Amps balanced
Power	220v Single Phase – 20 Amps

Table Size	Cutting Area	Machine Size	Vacuum Zones
Apex 1713	66 in x 51 in	98 in x 67 in	15
Apex 2513	98 in x 51 in	126 in x 83 in	15
Apex 2517	98 in x 66 in	126 in x 95 in	15



OPTIONAL

Optical Auto Tool Calibration

Control the cutting depth accuracy with displacement sensor through automatic knife initialization

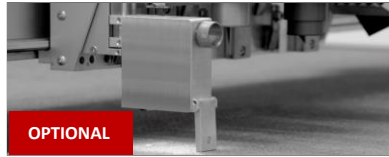

OPTIONAL

Precise Automatic Positioning System

With the high precision CCD camera the Apex Plus accounts for multiple types of printer distortion that matches up for high accuracy cuts



OPTIONAL

1 kW Router

Milling up to 60,000 RPM for cutting Acrylic, MDF, ABS plate & other hard materials.

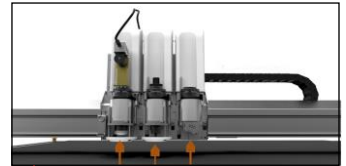

Efficient Cutting Heads

The max cutting speed is 1.m/s (4 to 6 times faster than manual cutting) which will considerably increase the production efficiency



OPTIONAL

Continuous Cutting System

Automated conveyor system makes feeding, cutting and collection work together. Continuous cutting function can cut long pieces saving labor cost and increasing productivity.

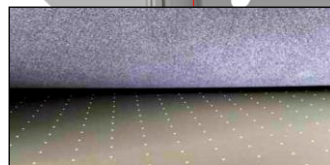

Precision Aluminum Table

With multiple vacuum zone system for accurate material hold down.

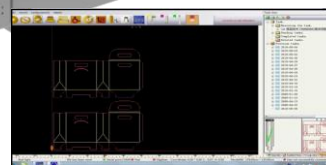

Motion Control System

Cutter Server makes the cutting process smooth, effective and perfect



Safety Device

Operational safety control ensures the security of the operator

Apex Plus Tables

Modular design for installations with entry space limitations (build on-site)



Gear Drive

Providing high speed durability

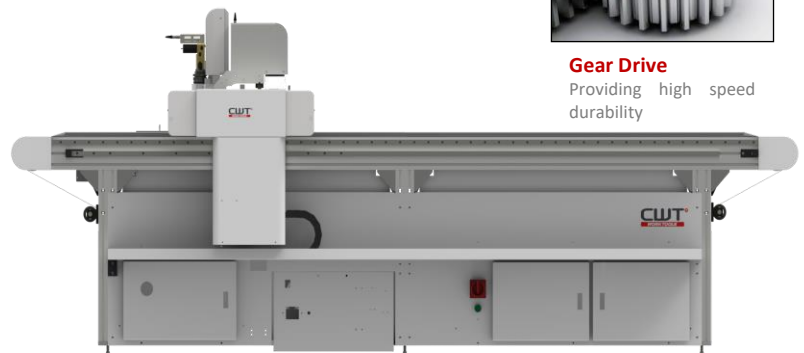

Max Cutting Speed	1500mm/s 59 in/s
Cutting Accuracy	0.1mm
Max. Cutting Thickness	50 mm 1.96 ins
Data Format	DXF, HPGL, PDF
Interface	Serial Port
Media	Vacuum System
Pump Power	220v 3 Phase 60-200 Amps balanced
Power	220V Single Phase 20 Amps 30 Amps with 1 kW Router

Table Size	Cutting Area	Machine Size	Vacuum Zones
Apex 2516	98 in x 63 in	130 in x 91 in	9
Apex 2521	98 in x 83 in	130 in x 115 in	12
Apex 2532	98 in x 126 in	130 in x 158 in	18
Apex 3516	138 in x 63 in	170 in x 91 in	12
Apex 3521	138 in x 83 in	170 in x 115 in	16
Apex 3532	138 in x 126 in	170 in x 158 in	24
Apex 5516	217 in x 63 in	249 in x 91 in	21
Apex 5521	217 in x 83 in	249 in x 115 in	24
Apex 5532	217 in x 126 in	249 in x 158 in	24

APEX Tools



Electronic Oscillating Tool with 1 mm stroke for cutting soft and medium density materials.



Router has a rotary speed up to 60,000 rpm. Designed for solid performance in a wide range of applications and substrates. The Router can also do precision engraving like the Kiss-Cut tool.



Universal Cutting Tool for through-cutting materials with thicknesses up to .196 inch. High speed cutting for maximum productivity.



V-Cut Tools is perfect for producing complex structural designs from foam core or bonded materials. The tool can be set for cutting 5 different angles. 0°, 15°, 22.5°, 30°, 45°.

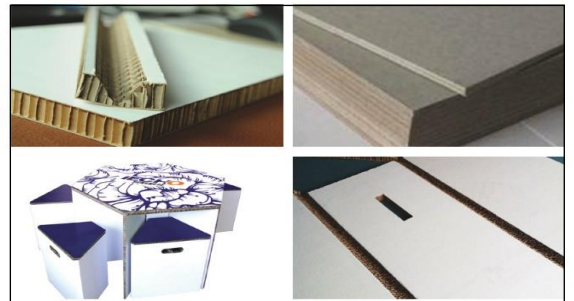

Kiss Cut Tool for cutting vinyl, foil, films, thin media, cardboard, textiles and other thin substrates.



Creasing Tool is used to produce creases on corrugated materials. Multiple tools allow the creation of perfect creases on a variety of materials.



Rotary Drive Tool for high speed cutting of textiles.



Pneumatic Oscillating Tool is an air driven device with a high oscillating frequency. The 8 mm stroke is suitable for cutting rigid and high-density materials up to 1.5 inches thick utilizing a specialized blade.

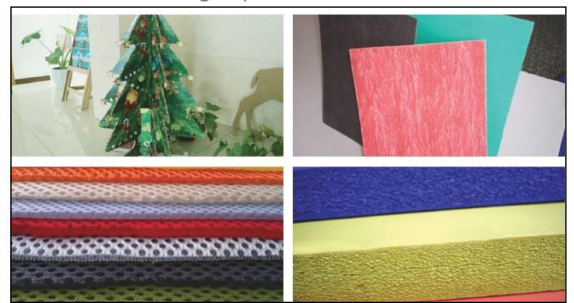

CWT Worktools USA, 8101 Tristar Drive, Suite 110, Irving, TX 75063

Warehouses in Dallas, TX • Logan Township, NJ • Los Angeles, CA

Phone: 469-758-2288 • www.cwtworktoolsusa.com • sales@cwtworktoolsusa.com